

A-A (4:1)

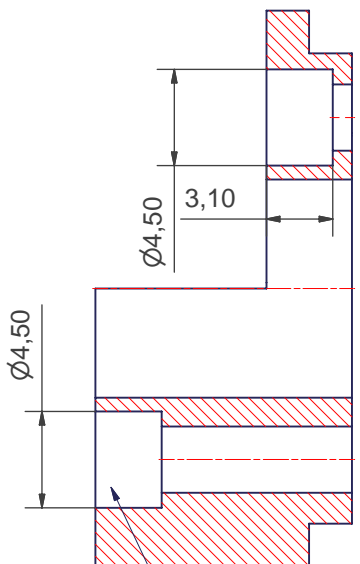

Der laves skruer til disse 2 huller

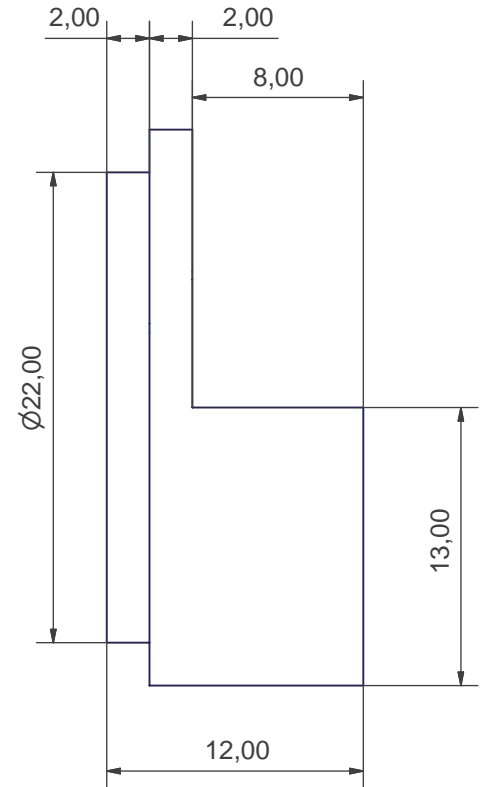
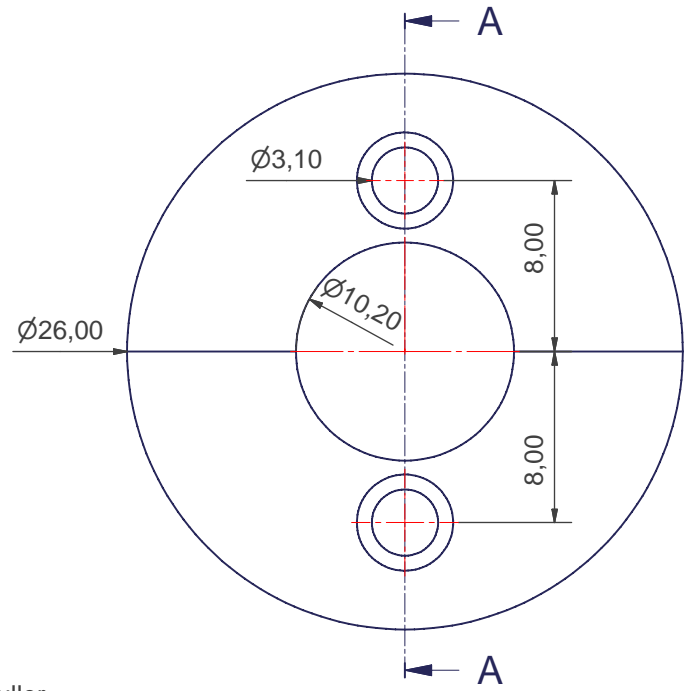

B-B (4:1)

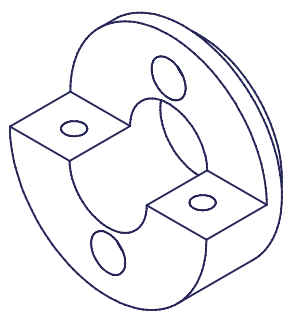
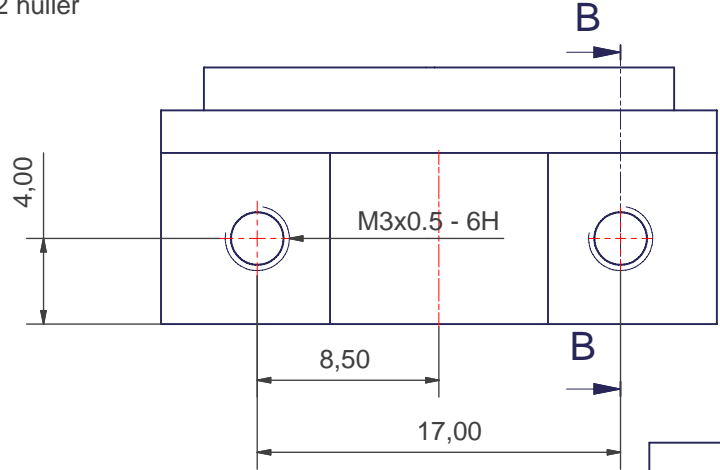
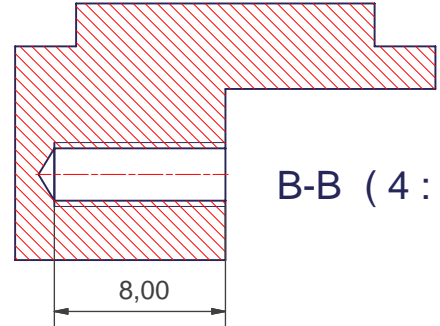

Institute of Physics and Astronomy Aarhus Universitet			Mtr	Stainless Steel, 304
			Designer	John E. Andersen
		Project	Input V-Block	
		Creation date	Last saved	
		13-10-2004	27aug04 - 8:48am	
		3-yderrør		Rev no.
		Q:\Inventor DWG\Søren Frandsen\FIES\Input V-block\Fiber håndtag\3-yderrør.ipt		A3